



DIAMIL

Tube scarfing
Scordonatura

We manufacture exactly what you need

Facciamo esattamente ciò di cui avete bisogno

This is our approach to customers and this is the way we design hard metal parts. Direct contact with our skilled technicians is the way to get it. Discover the value of a special supplier!

Questo è il nostro approccio al cliente e la nostra politica di sviluppo del prodotto. La comunicazione diretta con il nostro personale tecnico è il modo di realizzarla. Scoprite il valore aggiunto di un fornitore speciale.





The company

L'azienda

Diamil is a Harditalia srl trade mark for the sale of inserts and tools dedicated to iron and steel industry. Harditalia srl, member of OMCD Group, is a sintered hard metal producer with a leading position in the Italian market. Our inserts, thanks to a well developed know how in hard material matter due to a 40 year experience and profitable partnership with the other Group companies, are made with a wide range of carbide mixtures. A very well equipped laboratory of R&D supports the development of new products to keep our inserts constantly at the top in the market. Advanced technologies plus high professional skills plus a strong attention to please and achieve the best result to satisfy Customers are parts of Diamil's life style. Our policy is based on a promptly answer to customers needs; this is possible thanks to a ready on shelf delivery and flexible approach to customer inquiry. Diamil also provide a pre-&after sale full service offering advice and technical know-how, cooperating with customers in order to find the best practical solutions to production problems. Full customer satisfaction is our goal and what we work for everyday!



Diamil è il marchio con il quale vengono commercializzati gli inserti e gli utensili prodotti da Harditalia srl destinati all'industria siderurgica. Harditalia è una delle società del Gruppo OMCD che produce sinterizzati e vanta una posizione di leader tra i fabbricanti di metallo duro per applicazioni industriali in Italia. Il know how sviluppato in questi anni, grazie anche agli interscambi con le aziende consociate, permette ai nostri inserti di venire realizzati contando su un'ampia gamma di "miscelate do carburi", nonché su attrezzature all'avanguardia e di essere sviluppati con il supporto di un moderno ed efficiente laboratorio di ricerca e sviluppo. La tecnologia, l'alta competenza professionale e la continua attenzione al raggiungimento del miglior livello di soddisfazione del cliente sono da sempre le direttive fondamentali, che ci rendono il partner ideale nel fornire utensili affidabili e controllati ad ogni passo della filiera produttiva. Flessibilità del servizio, puntualità e velocità nelle consegne, rese possibili da importanti magazzini di stoccaggio, ci consentono di far fronte in tempi molto brevi alle richieste consulenza tecnica pre e post-vendita, in grado di fornire soluzioni complete, di scegliere in modo puntuale i materiali e le attrezzature più idonee alle singole applicazioni. L'impegno costante e motivato del team Diamil porta ad un'offerta di prodotti e servizi mirati a garantire i più elevati standard qualitativi.

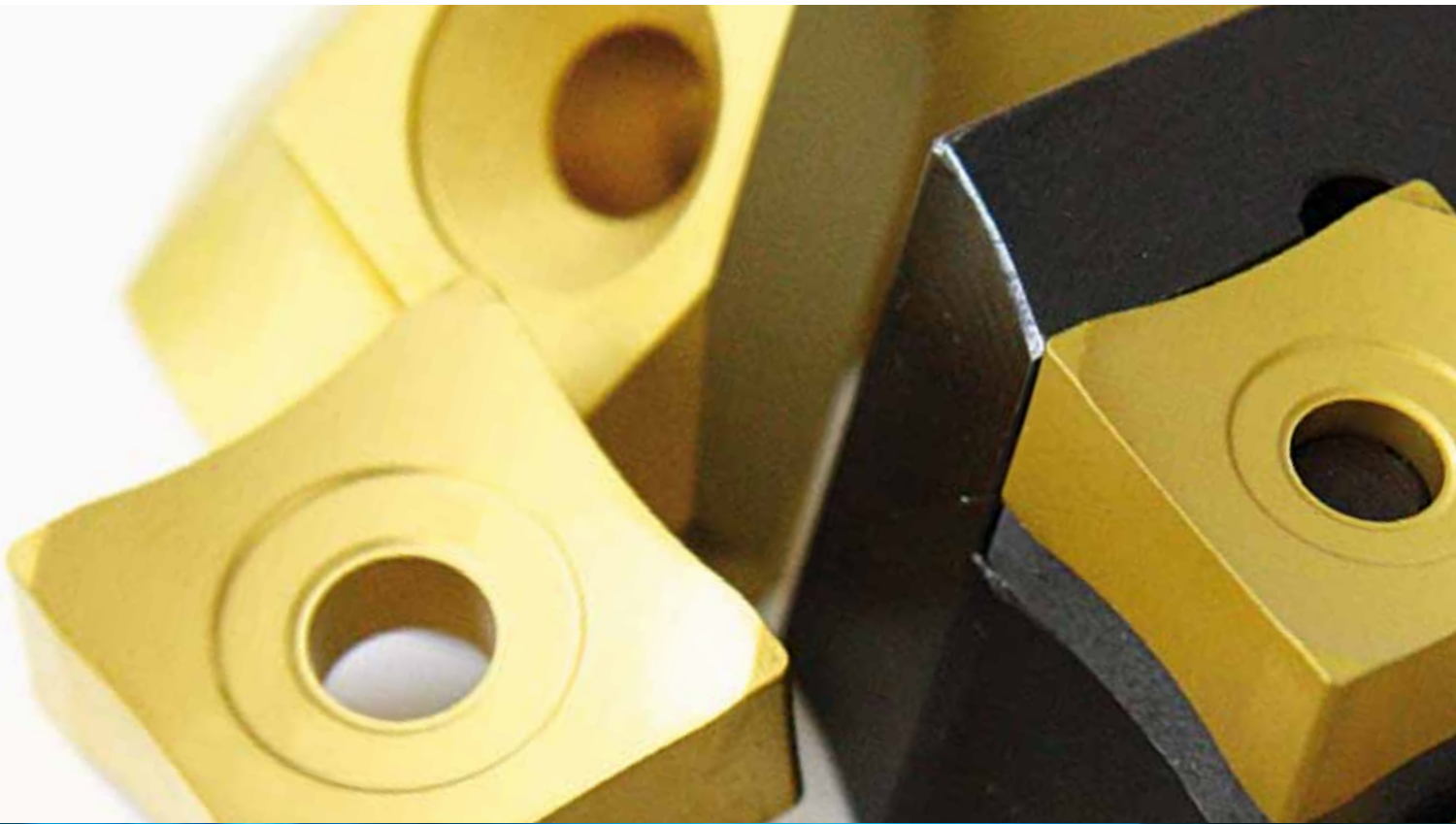

- **External Inserts in stock**
Inserti per esterno a magazzino
- **External Inserts on demand**
Inserti per esterno non a magazzino
- **External scarfing**
Scordonatura esterna
- **Internal scarfing in stock**
Scordonatura interna a magazzino
- **Internal scarfer on demand**
Scordonatori interni speciali
- **Chamfering inserts and toolings**
L'utensileria e gli inserti per la bisellatura

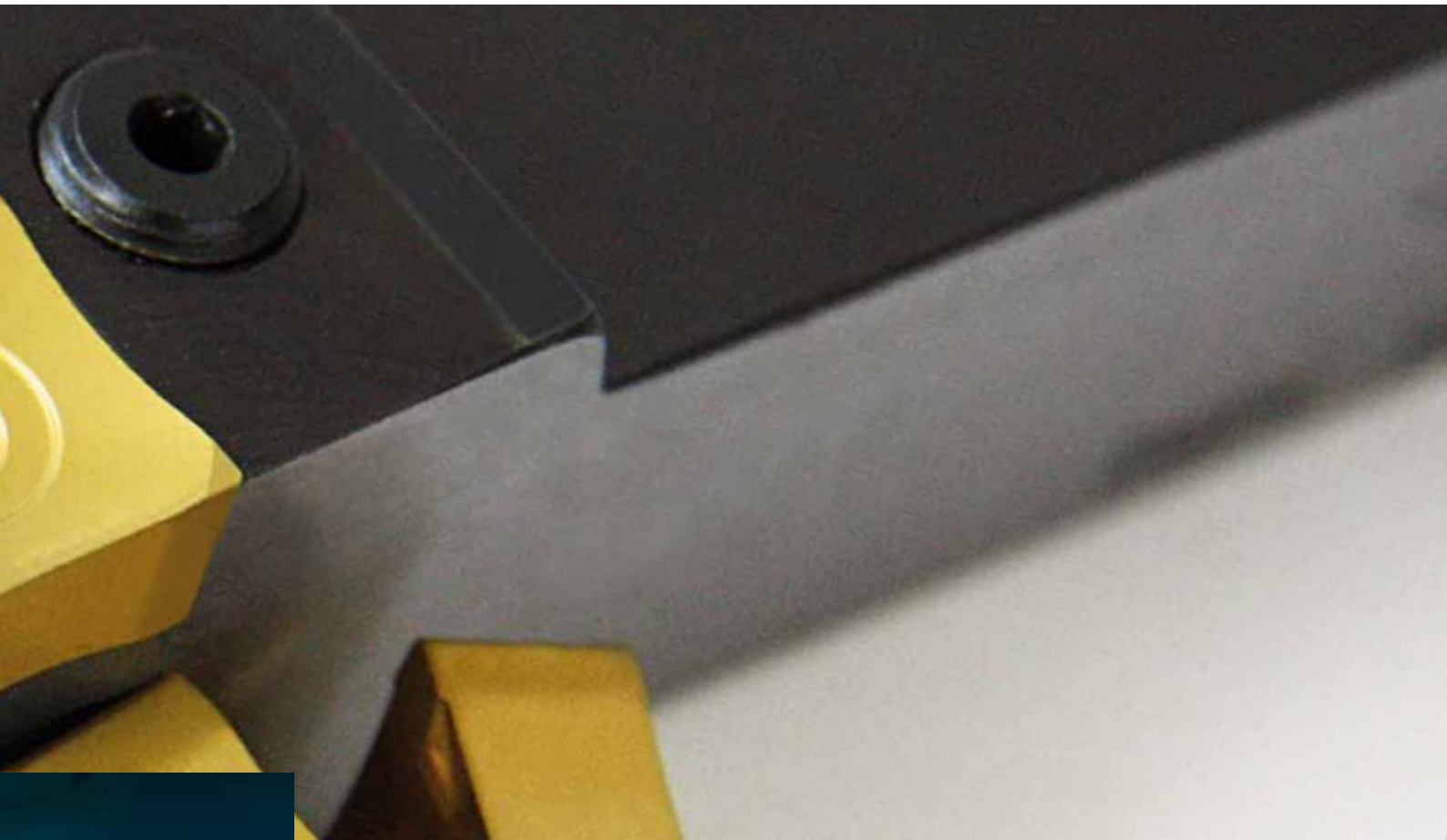

Tube scarfing

La scordonatura del tubo saldato

After ten years of hard labour and experience in the Italian market as a leader in the production of tube scarfing inserts, Diamil has realized this new catalogue which includes the standard offer of internal and external scarfer plus a wide range of special inserts used world wide. The very flexible organization plus the know-how collected through a continuous monitoring of the market has brought us to better understand our costumer needs. Diamil has introduced new hard metal grades and new shapes to provide a product that can satisfy the always increasing and fast demands created by the market without forgetting our prime target: the costumers' approval and satisfaction.

Dopo più di dieci anni di attività come leader sul mercato italiano nella produzione di inserti per la scordonatura del tubo, Diamil ha realizzato questo catalogo che include l'offerta standard di inserti per interno ed esterno ed una vasta gamma di inserti speciali. La struttura flessibile ed un ottimo know how tecnico ci permettono di andare incontro alle esigenze del cliente realizzando inserti ed utensileria speciali in tempi decisamente brevi. La continua analisi del mercato ci porta ad innovare continuamente il nostro prodotto con l'inserimento di nuovi gradi e nuove geometrie al fine di avere una offerta sempre competitiva volta al completo soddisfacimento del cliente.







Our grades

I nostri gradi

In order to optimize the hard metal substratum-coating system we have developed a number of different combined grades shown in the below table. The application field is an indicative suggestion, we strongly suggest to ask to our technicians for the best solution fitting your machining.

L'offerta si articola su diversi gradi studiati come sistema metallo duro-rivestimento. Nella tabella vengono riportati i gradi più utilizzati con una indicazione dei campi di impiego.

Grade/Grado	Description/Descrizione	Application field/Campo di applicazione
M813G P812G	Standard grade Grado standard	General purpose Uso generale
P712G	High quality grade Grado alta qualità	High speed mill, hard steel Alta velocità acciai duri
M811N	Special high quality grade Grado speciale alta qualità	High speed mill Alta velocità
P40	Special grade for uncoated insert Grado speciale per inserti non ricoperti	General purpose Uso generale

Inserts in stock

Inserti a magazzino

The Diamil insert's line allows several solutions for external tube scarfing. We supply items sizes 15-19-25, with negative and positive cutting edge. The new cheapbreaker type guarantees better welding bead control, achieving a very good chip management not otherwise obtainable.

La gamma di inserti offerta da Diamil consente diverse soluzioni per la scordonatura esterna. Nei tre diversi formati (lato 15,19 e 25mm) forniamo inserti sia negativi che positivi. La nuova serie con rompitruciolo garantisce un migliore controllo del cordone di saldatura in direzione e in lunghezza, assicurando una gestione del truciolo altrimenti non ottenibile.

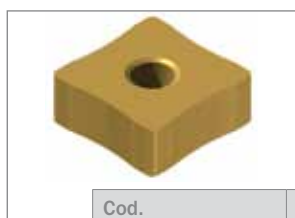

Cod.	Radii available/Raggi disponibili
SNMX 150605-01	7-9-11-13-15-18-20-22-25-27-30-35-40-45 50-60-70-75-80-90-100
SNMX190608-02	10-18-22-30-40-50-75-100 (*)
SNMX 250916-01	50-75-100-120-140-160-180-200 (*)



Cod.	Radii available/Raggi disponibili
SNMX 150705-02	7-9-11-13-15-18-20-22-25-27-30-35-40-45 50-60-70-75-80-90-100
SNMX 190808-02	10-18-22-30-40-50-75-100 (*)
SNMX 251216-02	50-75-100-120-140-160-180-200 (*)



Cod.	Radii available/Raggi disponibili
SNMX 150705-03	7-9-11-13-15-18-20-22-25-27-30-35-40-45 50-60-70-75-80-90-100
SNMX 250916-03	100-120-140-160-180-200



Cod.	Radii available/Raggi disponibili
SNMX 150705-04	9-11-13-15-18-20-25-30-35-40-50-60-75 80-90-100
SNMX 190808-04	10-18-22-30-40-50-75-100 (*)

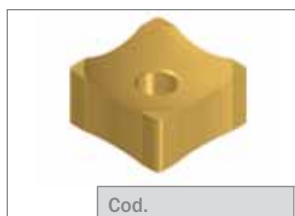

Cod.	Radii available/Raggi disponibili
SNMX 150712-05	11-13-15-18-20-22-25-30-40-50-75

*Different radii on demand
*Altri raggi eseguibili a richiesta

Inserts on demand

Inserti non a magazzino



Cod.	Radii available/Raggi disponibili
LGMN 2005	10-20-30-40-50-70-100

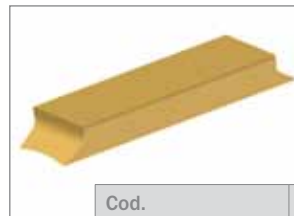

Cod.	Radii available/Raggi disponibili
LOGX 4005	10-20-30-40-50-70-100



Cod.	Radii available/Raggi disponibili
ROMX 2404	10-15-20-25-30-40-50-70-100



Cod.	Radii available/Raggi disponibili
SDUW 190600	10-15-20-25-30-40-50-70-100
SDUW 250900	75-100-120-150-200



Cod.	Radii available/Raggi disponibili
SDMX 190616	10-15-20-25-30-40-50-70-100
SDMX 250912	75-100-120-150-200



Cod.	Radii available/Raggi disponibili
LOGN 150560	10 to 100

External scarfing

Scordonatura esterna

RADIUS CHOICE

In the following table can be found the correct choice of the insert radius depending on the range of diameters to be worked. Due to the failure parallelism between the insert' surface and the tube, there isn't a linear correspondence between them.

LA SCELTA DEL RAGGIO

La seguente tabella facilita la corretta scelta del raggio dell'inserto in funzione della gamma di diametri che si vuole lavorare. A causa infatti del mancato parallelismo tra il piano di appoggio dell'inserto ed il diametro del tubo, non esiste una corrispondenza diretta tra i due.



Tube diameter/Diametro tubo		Radii/Raggi
Type/Tipo 01	Type/Tipo 02	r.
min-max	min-max	
8->13.5	8->13.5	7
13.5->17	12.5-<16	9
17->21	16->20	11
21->25	20->24	13
25->29	24->28	15
29->33	28->33	18
35->39	22->37	20
39->43	37->41	22
43->49	41->45	25
49->53	45->50	27
53->59	50->54	30
59->69	54->62	35
69->79	62->70	40
79->89	70->78	45
89->99	78->85	50
99->149	85->120	75
149->198	120->150	100

OUR TOOLS

Diamil design and produce tooling with a screw, stirrup and hard metal support plate fixing system. Every insert has its own fixing system as showed in the schedule below.

I NOSTRI UTENSILI

Diamil realizza una propria gamma di utensili a stelo con sistema di fissaggio tramite vite, leva e supporto in metallo duro. Il fissaggio di ciascun inserto è garantito dal relativo sistema di bloccaggio così come riportato nella seguente tabella.

Tool's code Codice Utensile	Tools dimensions Dimensione Utensile		Insert Inserto	Size Inserto	Spare parts Ricambi			
	BXH	L						
DMPN /N/R/L 202015-90	20	125	SNMX 150605 01 SNMX 150705 02 SNMX 150705 03 SNMX 150705 05	15	PL113	V03	PSX-315.10 PSX-315.11 PSX-315.10 PSX-315.10	CH 3
DMPN /N/R/L 202015-75								
DMPN /N/R/L 252515-90	25	150						
DMPN /N/R/L 252515-75								
DMPN /N/R/L 252519-90	25	150	SNMX 190808 01 SNMX 190808 02	19	PL114	V04	PSX-319.10 PSX-319.11	CH 4
DMPN /N/R/L 323219-75	32	170						
DMPN /N/R/L 323225-75	32	170	SNMX 250916 01 SNMX 251216 02 SNMX 251216 02	25	PL116	V05	PSX-325.10 PSX-355.11 PSX-325.10	CH 5

SPECIAL SHAPES

Diamil produce special solution designed to satisfy particular customer needs. Every tool is supplied with its own fixing system. In the following drawing and table you will find the main dimension to be specified in case of order.

L'UTENSILERIA SPECIALE

Diamil offre anche soluzioni personalizzate di utensileria, con le relative parti di ricambio. Nel disegno e relativa tabella seguente sono riportate le misure parametriche da indicare in caso di ordine di utensileria speciale.

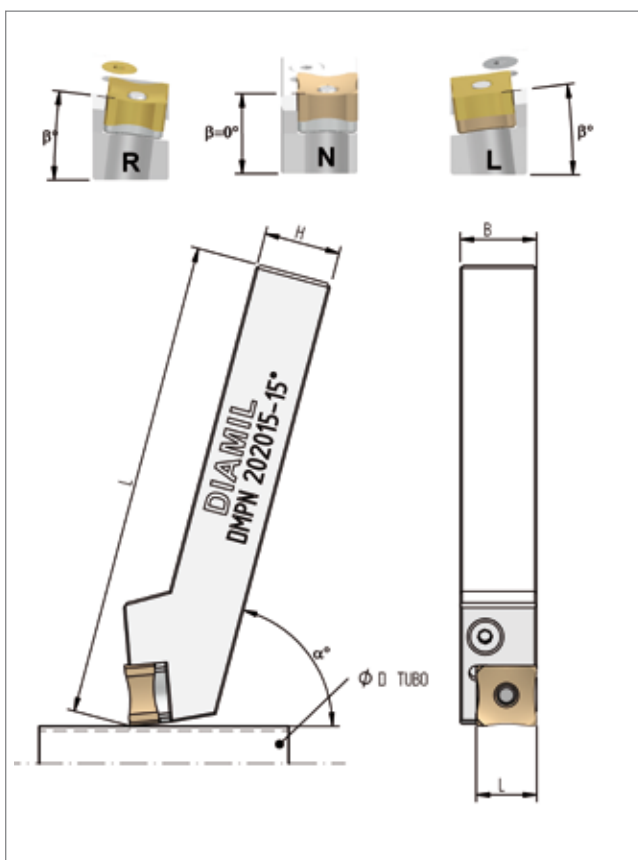

Table of dimensions/Tabella delle dimensioni	
Shank width/Larghezza stelo	B
Shank height/Altezza stelo	H
Shank length/Shank length Lunghezza stelo	L
Dimensions of insert/Dimensioni inserto	15-19-25
Degree top rake/Inclinazione spoglia sup.	β°
Inclination of head/Inclinazione torretta	α°
Direction/Orientamento	R-N-L

Internal scarfing in stock

Scordonatura interna a magazzino

CUTTING RINGS

Diamil features the complete line of hard metal rings for internal scarfing. The table below shows the codes of different inserts which are available in versions 42° and 48°.

Depending on the customer's needs, they can be supplied in different degrees, PVD or CVD coated, or without any coating.

ANELLI

Diamil offre la gamma completa di anelli in metallo duro per scordonatura interna. Nella tabella di seguito sono riportati i codici dei diversi inserti, disponibili nelle versioni 42° e 48°.

A seconda delle esigenze del cliente gli stessi possono essere forniti in gradi differenti con o senza ricopertura.

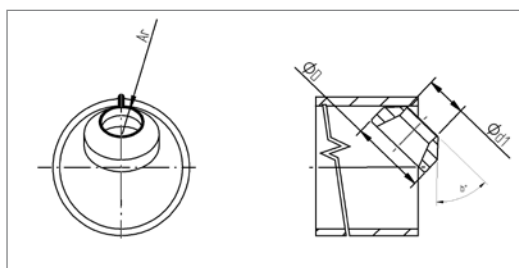

Cod.	Working range/Gamma di lavoro	D
SR0 AR4,5	14-17	8
SR0 AR5,5	16-17	
SR0 AR6,0	16-19	
SR0 AR6,5	17-20	10
SR1 AR07	20-22	
SR1 AR08	22-24	13
SR1 AR09	24-26	
SR2 AR10	26-28	19
SR2 AR11	28-30	
SR2 AR12	30-34	
SR3 AR14	32-41	22
SR3 AR17	41-50	
SR4 AR23	48-72	30
SR5 AR25	70-85	35
SR5 AR28	85-100	
SR6 AR30	90-110	45
SR6 AR34	100-130	
SR7 AR39	125-160	50
SR8 AR46	150-260	55

Angle/Angolo	Application field/Campo di applicazione
42°	General purpose/Usò generale
48°	Alluminized tubes/Tubi alluminati

Grades/Grado	Description/Descrizione	Application field/Campo di applicazione
P40	Uncoated/Non rivestito	General purpose/Usò generale
P212G	PVD coated/Ricoperto PVD	Alluminized tubes/Tubi alluminati
M112G	CVD coated/Ricoperto CVD	High performance general purpose Alte prestazioni, uso generale

Internal scarfer on demand

Scordonatori interni speciali

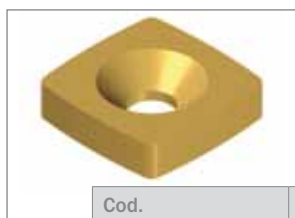

Cod.	Radii available/Raggi disponibili
SNMW 2507	35-50-75-100-120
SNMW 3808	75-100-120-150-200

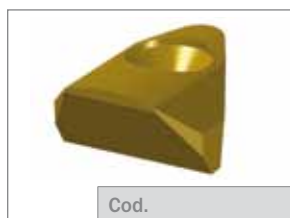

Cod.	Radii available/Raggi disponibili
TBMX 1409	50-75



Cod.	Radii available/Raggi disponibili
LFGW 3109	25-50

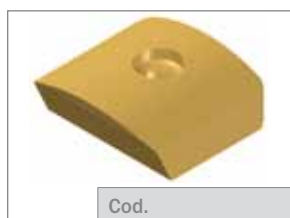

Cod.	Radii available/Raggi disponibili
LFGX2509	25-50-75 100

INTERNAL SCARFING TOOLS

We produce inside deburring tools and cutting ring holders, using tungsten carbide for wear parts (wheelsand pins). Diamil provides both the assembled and individual parts.

L'UTENSILERIA

Diamil realizza mandrini e testine per la scordonatura interna, utilizzando metallo duro per i componenti maggiormente esposti ad usura (ruote e perni). Diamil fornisce sia gli assemblati che le singole parti di ricambio.

Cod.	Working range Gamma di lavoro
RIME014	14-17
RIME017	17-21
RIME1	20-26
RIME2	26-34
RIME3	32-50
RIME3,5	40-55
RIME4	48-72
RIME5	70-100



Chamfering inserts and toolings

L'utensileria e gli inserti per la bisellatura

Allied to the service given to the scarfing department Diamil is capable of supplying a wide range of "chamfering products" like hard metal inserts and tips, tool holders and tightening bolts. Diamil also supplies chamfering heads spare parts, like cartridge and adjusting screw. Under specific request the technical department designs the whole system for the customer.

A completare l'offerta per le linee di scordonatura Diamil offre una gamma completa di prodotti per la bisellatura delle barre. Fanno parte di questa gamma gli inserti in metallo duro, le relative sottopiacchette ed i sistemi di fissaggio. Diamil realizza anche parti di ricambio della testa di bisellatura quali cartucce, sedi o viti di regolazione.

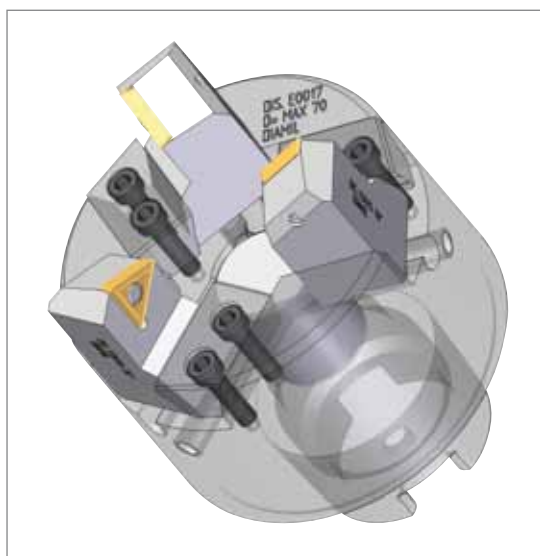

Cod.	H40K	H40P
	K40	P40
CNMX 160616	+	0
SNUC 200600	+	0
SPLT 120408	+	0
SNMM 250724	+	0
TNMG 220408	+	0
TNMM 440916	+	0
TPUN 160308	+	0
TPUN 220412	+	0
TPUN 270616	+	0
TPUN 330616	+	0
TPMR 160208	+	0
TPMR 220412	+	0
TPMR 270616	+	0

+ in stock/disponibile a magazzino
 0 on demand/su richiesta

in the world

- Harditalia headquarter
- R Harditalia representative

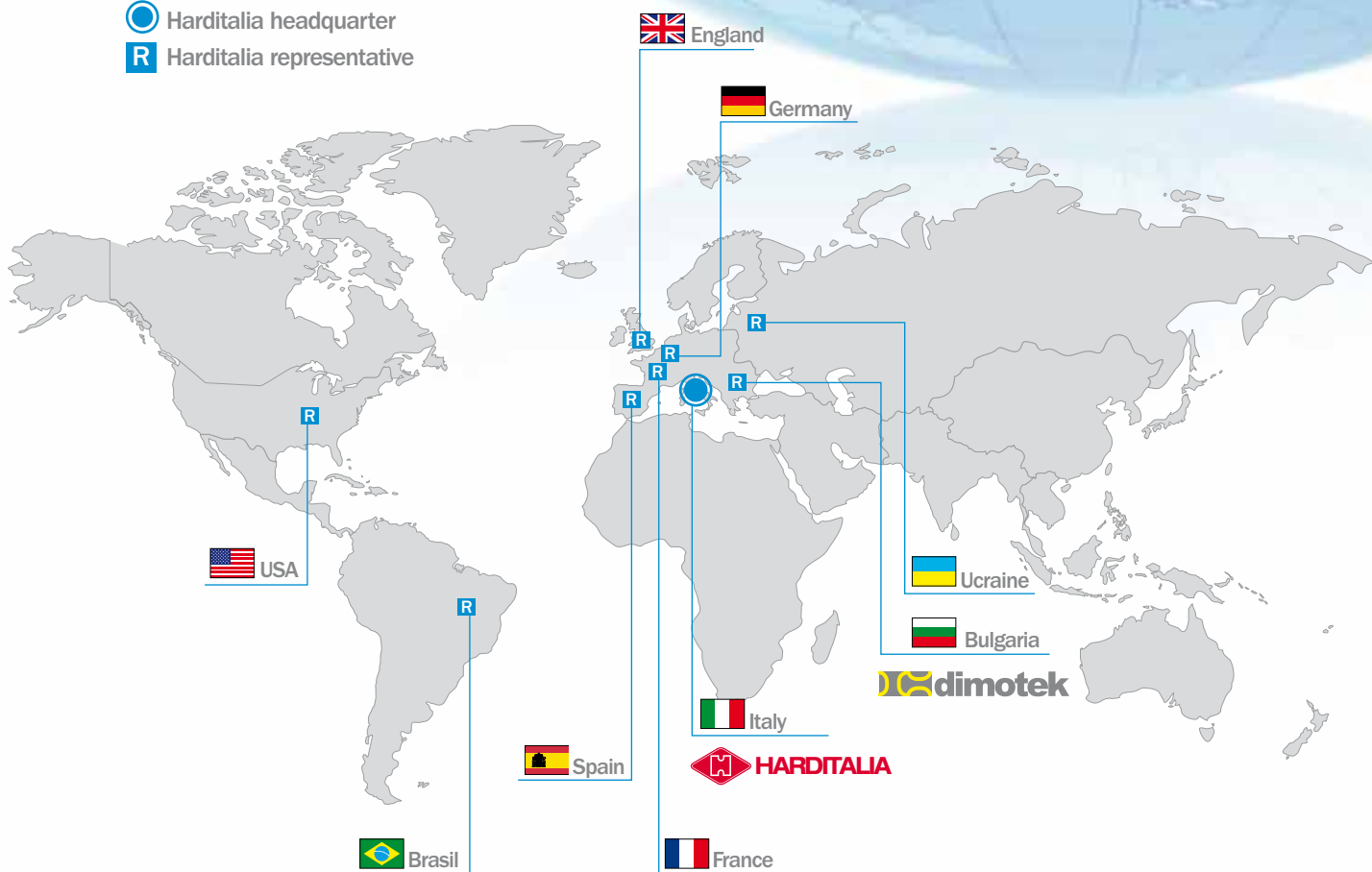



DIAMIL

a brand of



HARDITALIA

hard metal items

a competence powered company
of Gruppo OMCD

Harditalia srl
Via Genova 9 - Oggiona con S.Stefano - 21040 (Va) Italia
Tel. +39 0331 215007 - Fax +39 0331 215024
harditalia@harditalia.com



www.harditalia.com

www.omcd.it